

START HERE!

READ ME FIRST

Don't be a hero and muscle through this installation without reading these fitting instructions first! Improper installation of this gear may void certain aspects of your warranty.

Before you begin, take a moment and open all your Front Runner rack kit boxes and gather the assembly instructions for the various components.

A complete kit will contain:

1. A Front Runner Mounting System specific to your vehicle
2. A Front Runner Rack Tray or Load Bar Slats

This document will guide you through the assembly of the mounting system and assist you in fitting the roof rack tray or load bars to your specific vehicle.

Please refer to the next page for a list of all the components, quantities and tools required.

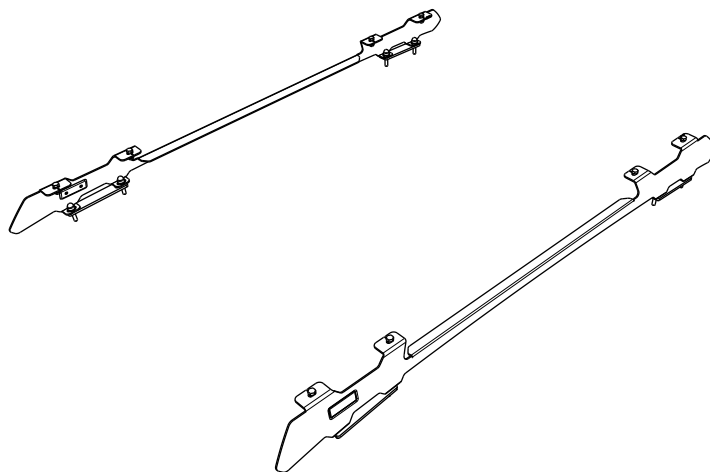

IMPORTANT WARNING! ⚠

IT IS CRITICAL THAT ALL FRONT RUNNER PRODUCTS BE PROPERLY AND SECURELY ASSEMBLED AND ATTACHED TO YOUR VEHICLE. IMPROPER ATTACHMENT COULD RESULT IN AN AUTOMOBILE ACCIDENT, AND COULD CAUSE SERIOUS BODILY INJURY OR DEATH. YOU ARE RESPONSIBLE FOR ASSEMBLING AND SECURING ALL FRONT RUNNER PRODUCTS TO YOUR VEHICLE, CHECKING THE ATTACHMENTS PRIOR TO USE, AND PERIODICALLY INSPECTING THE PRODUCTS FOR ADJUSTMENT, WEAR AND DAMAGE. THEREFORE, YOU MUST READ AND UNDERSTAND ALL OF THE INSTRUCTIONS AND PRECAUTIONS SUPPLIED WITH YOUR FRONT RUNNER PRODUCT PRIOR TO INSTALLATION OR USE. IF YOU DO NOT UNDERSTAND ALL OF THE INSTRUCTIONS AND CAUTIONS, OR IF YOU HAVE NO MECHANICAL EXPERIENCE AND ARE NOT THOROUGHLY FAMILIAR WITH THE INSTALLATION PROCEDURES, YOU SHOULD HAVE THE PRODUCT INSTALLED BY A PROFESSIONAL INSTALLER OR OTHER QUALIFIED PERSONNEL.

NOTE: Front Runner will not be responsible for any damage caused by the failure to install the product according to these instructions.

Please call us if you have any questions about the installation of this product.

1

GET ORGANIZED

IN THE BOX

1	2 X	Foot Rail LH / RH
2	8 X	M8 x 20 Hex Bolt
3	8 X	M8 x 16 x 1.6 Flat Washer
4	8 X	M8 Nyloc Nut
5	16 X	M8 Nut Cap
6	2 X	Plastic Spacer 145mm Long
7	2 X	Plastic Spacer 165mm Long
8	8 X	M8 x 19 x 2 Flat Washer
9	8 X	M8 Spring Washer
10	8 X	M8 x 40 Hex Bolt

TOOLS NEEDED

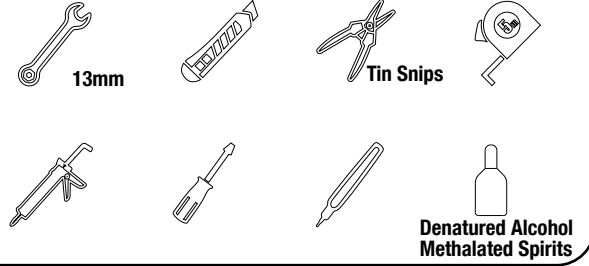
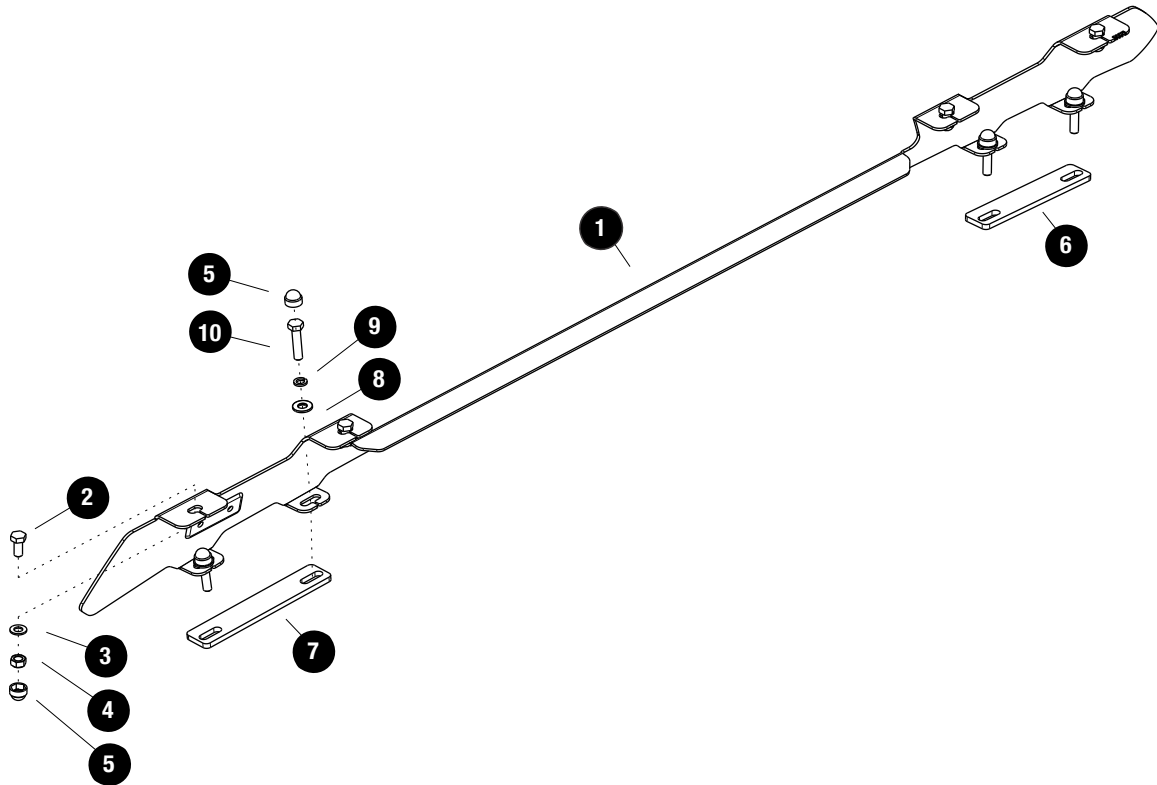
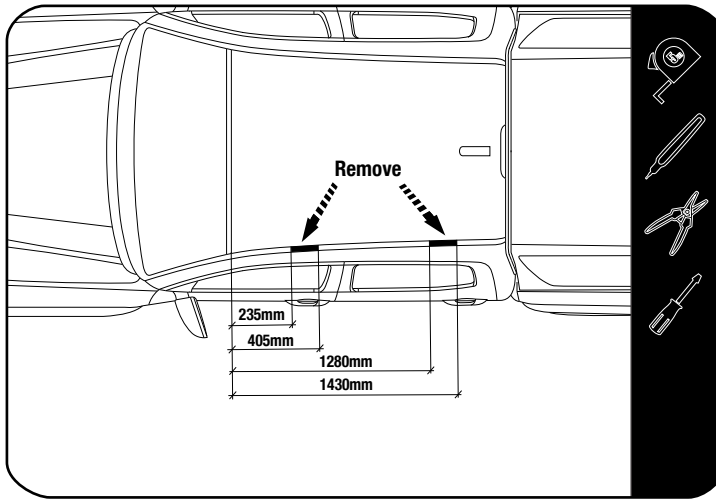

FIGURE 1.1



2.1



Starting at the front of the windscreen as shown, measure along the Ditch Moulding towards the rear of the vehicle. Mark the ditch moulding at the following distances.

- 235mm
- 405mm
- 1280mm
- 1430mm

Using a suitable panel tool, or screw driver wrapped in tape, lift the Ditch Moulding between the marks you made. Using tin snips, cut the Ditch Moulding on the marks made in 2.1.



Be careful when lifting the Ditch Moulding not to lift it too high as this might damage the Moulding.

2.2

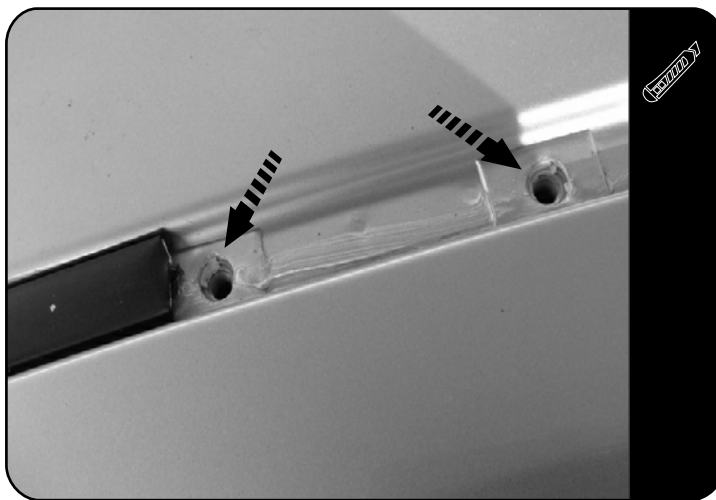

Looking at the Ditch, where you have just removed the Ditch Moulding, locate the four Threaded Mounting points in the vehicle's roof and remove the Protective Tape covering them.

2.3



Clean the area around the holes in the vehicle's roof using a rag and methylated spirits or denatured alcohol. Place some silicone around each hole in the vehicle's roof.

Place the plastic spacers 165mm long over the front holes (Item 7) & plastic spacers 145mm long over the rear holes (Item 6). Center the spacers in the vehicle's ditch, with the holes in the vehicle's roof.

Place some silicone in the cut outs of the spacers as shown.

2

FIT AND SECURE

2.4

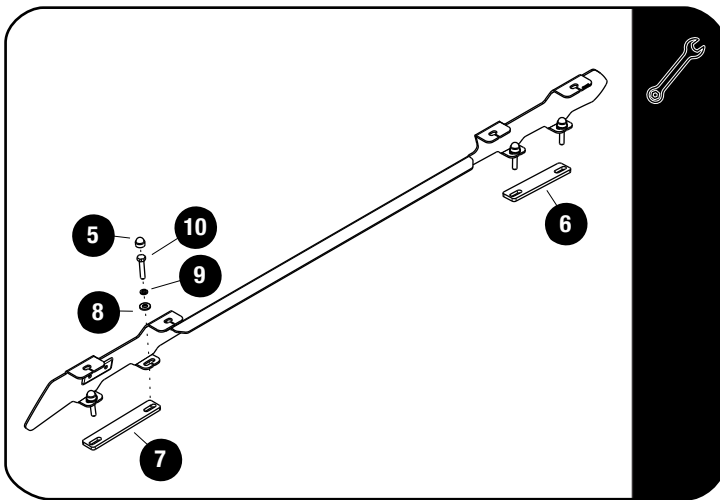

Place a bead of silicone down the threads of each bolt before inserting.

Place the Foot Rail (Item 1) onto the Spacers (Item 6 & 7), aligning the holes in the base of the Foot Rail with the center of the Spacers.

Secure the Foot Rail to the vehicle using the M8x40 Hex Bolts, M8 Spring Washers & M8x19x2 Flat Washers (Items 8, 9 & 10). Fully tighten.

Place M8 nut caps (Item 5) over all nyloc nuts.

3

FIT AND SECURE

3.1

Refer to RRSUNI when assembling your Slimline II Tray.



3.2

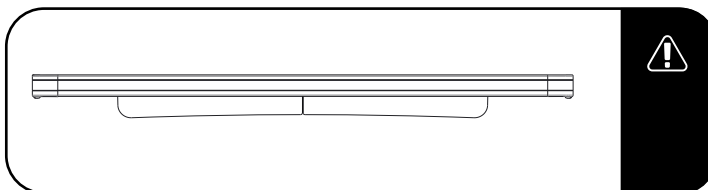

Make sure that the wind deflector is installed before you proceed to the next step.

3.3

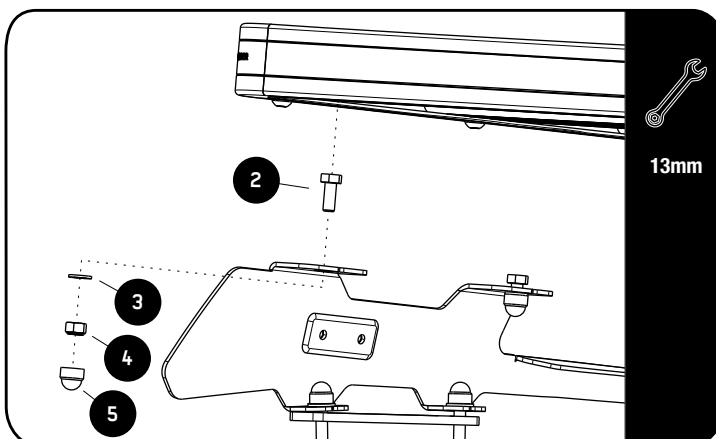

Fit your roof rack to the Foot Rails using M8 x 20 Hex Bolts, M8 x 16 x 1.6SS Flat Washers and M8 Nyloc Nuts (Items 2, 3 & 4) as shown.



Center the rack & fully tighten all fasteners. Place M8 Nut Caps (Item 5) over all Nyloc Nuts.

4

COMPLETION

4.1

Congratulations! You did it. Take a step back and admire your work!



5

INSTALL OTHER VEHICLE AND RACK ACCESSORIES

Now's the time to visit your favorite Front Runner Dealer in person or online.

IMPORTANT!

FRONT RUNNER RACK KITS OFTEN HAVE A HIGHER LOAD RATING THAN THE VEHICLES THEY ARE MOUNTED TO. PLEASE REFER TO YOUR SPECIFIC VEHICLE MANUFACTURER FOR A RECOMMENDED ROOF RATING. FRONT RUNNER CANNOT BE RESPONSIBLE FOR IMPROPER LOADING BEYOND THE VEHICLE MANUFACTURER'S STATED LOAD CAPACITY.

Be sure to tag us. We love to see our gear in action! #FrontRunnerOutfitters #BornToRoam

Share your adventures on: 