

## READ ME ! ⚠

Thank you for purchasing a recovery device mounting kit.

Before you start, take a moment to familiarize yourself with the Fitting Instructions and the included components.

Refer to Page 2 for a list of all the components, quantities and tools required.

## IMPORTANT WARNING! ⚠

IT IS CRITICAL THAT ALL FRONT RUNNER PRODUCTS BE PROPERLY AND SECURELY ASSEMBLED AND ATTACHED TO YOUR VEHICLE. IMPROPER ATTACHMENT COULD RESULT IN AN AUTOMOBILE ACCIDENT, AND COULD CAUSE SERIOUS BODILY INJURY OR DEATH. YOU ARE RESPONSIBLE FOR ASSEMBLING AND SECURING ALL FRONT RUNNER PRODUCTS TO YOUR VEHICLE, CHECKING THE ATTACHMENTS PRIOR TO USE, AND PERIODICALLY INSPECTING THE PRODUCTS FOR ADJUSTMENT, WEAR AND DAMAGE. THEREFORE, YOU MUST READ AND UNDERSTAND ALL OF THE INSTRUCTIONS AND PRECAUTIONS SUPPLIED WITH YOUR FRONT RUNNER PRODUCT PRIOR TO INSTALLATION OR USE. IF YOU DO NOT UNDERSTAND ALL OF THE INSTRUCTIONS AND CAUTIONS, OR IF YOU HAVE NO MECHANICAL EXPERIENCE AND ARE NOT THOROUGHLY FAMILIAR WITH THE INSTALLATION PROCEDURES, YOU SHOULD HAVE THE PRODUCT INSTALLED BY A PROFESSIONAL INSTALLER OR OTHER QUALIFIED PERSONNEL.

**NOTE:** Front Runner will not be responsible for any damage caused by the failure to install the product according to these instructions.

Please call us if you have any questions about the installation of this product.

# 1

## GET ORGANIZED

### IN THE BOX

1	2 X	Base Bracket
2	4 X	M8x16 Hex Bolt
3	4 X	M8x16x1.6 Flat Washer
4	4 X	M8 Nyloc Nut
5	4 X	M8 Nut Cap
6	4 X	M10x60 Hex Bolt SS
7	4 X	M10x100 Hex Bolt SS
8	8 X	M10x21x1.2 Flat Washer
9	4 X	M10x30x3 Flat Washer
10	4 X	M10 Eye Nut
11	4 X	M10 Nut SS
12	4 X	M10 Spring Washer
13	4 X	19x12.5x10 Tube Spacer

### TOOLS NEEDED



FIGURE 1.1

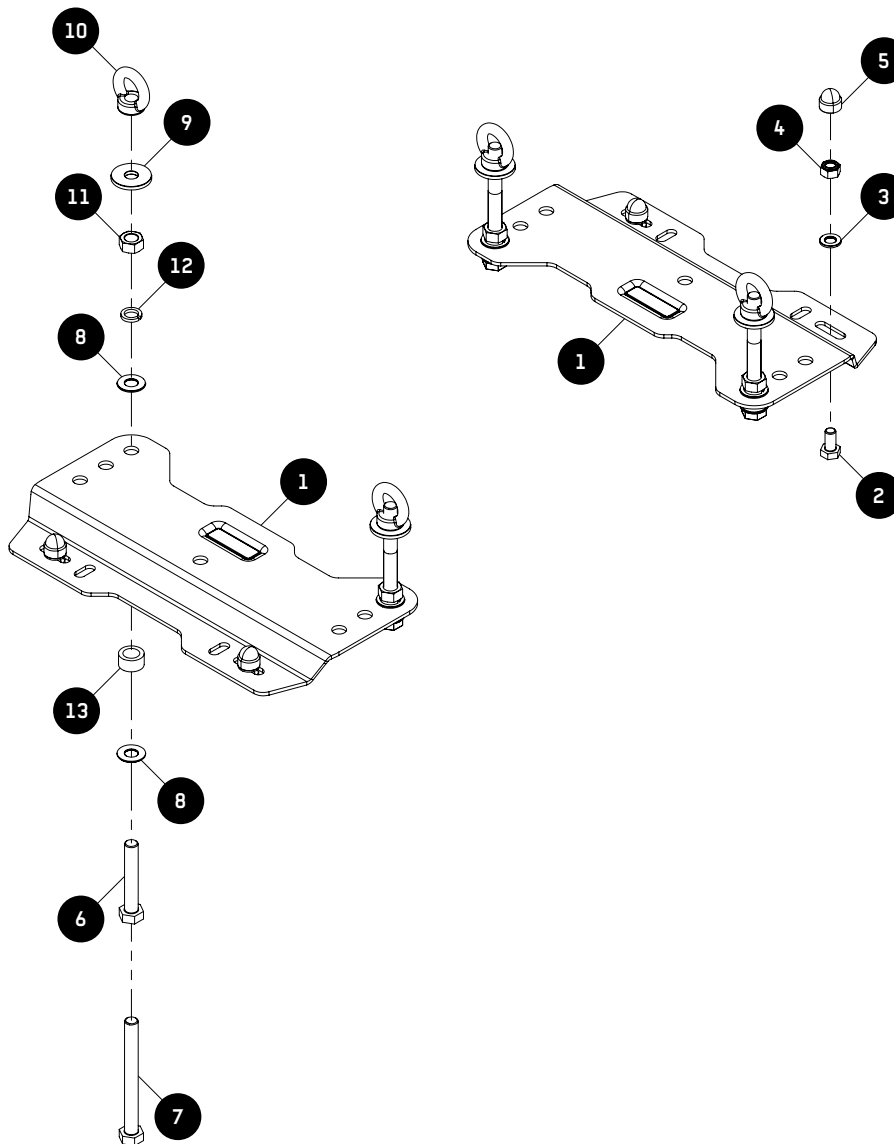

2

**FIT AND SECURE - SELECT RECOVERY BOARD HARDWARE**

2.1



🔄 The recovery device mounting kit is suitable for the following recovery boards.

- 2 x MaxTrax Mini
- 3 x MaxTrax Mini & 1 x Jaxbase
- 2 x MaxTrax Lite
- 4 x MaxTrax Lite
- 2 x MaxTrax MKII
- 4 x MaxTrax MKII
- 2 x MaxTrax Xtreme
- 4 x MaxTrax Xtreme
- 2 x Tred Pro
- 4 x Tred Pro

Select the correct hardware for your specific recovery board, using the configurations listed below.

2.2

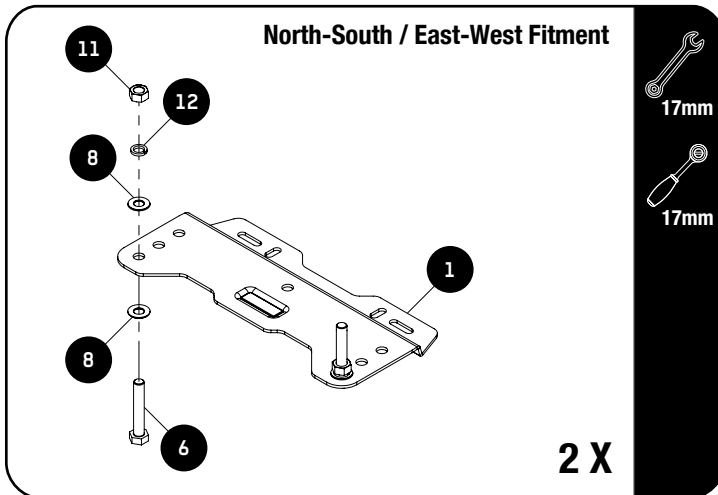

**2 X MAXTRAX MINI**

🔄 For 2 x MaxTrax Mini use the specified hardware.

Fully tighten the M10x60 Hex Bolts SS, M10x21x1.2 Flat Washers, M10 Spring Washers & M10 Nuts SS (Items 6, 8, 12 & 11) to the Base Bracket (Item 1) as shown.

You will need two of these assemblies.

MaxTrax Mini set sold separately (REQU230).

2.3

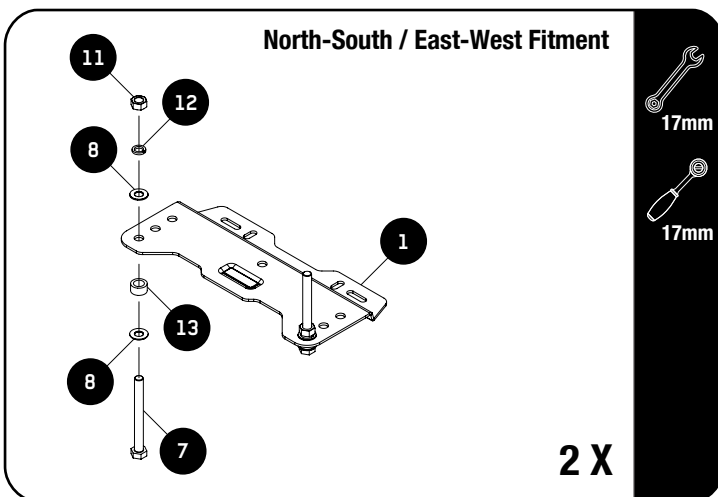

**3 X MAXTRAX MINI + 1 X JAXBASE**

🔄 For 3 x MaxTrax Mini + 1 x Jaxbase use the specified hardware.

Fully tighten the M10x100 Hex Bolts SS, M10x21x1.2 Flat Washers, 19x12.5x10 Tube Spacers, M10 Spring Washers & M10 Nuts SS (Items 7, 8, 13, 12 & 11) to the Base Bracket (Item 1) as shown.

You will need two of these assemblies.

MaxTrax Mini and Jaxbase combo set sold separately (REQU258), includes 1 x Mini + 1 x Jaxbase.

**FIT AND SECURE - SELECT RECOVERY BOARD HARDWARE**

2.4

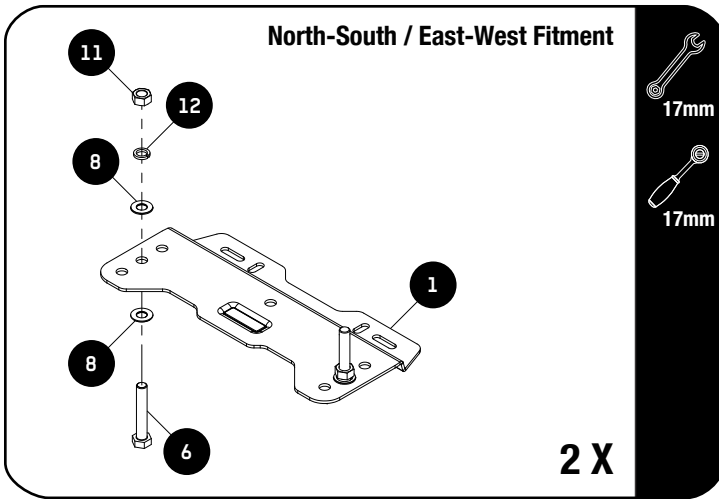

**2 X MAXTRAX LITE**

For 2 x MaxTrax Lite use the specified hardware.

Fully tighten the M10x60 Hex Bolts SS, M10x21x1.2 Flat Washers, M10 Spring Washers & M10 Nuts SS (Items 6, 8, 12 & 11) to the Base Bracket (Item 1) as shown.

You will need two of these assemblies.

MaxTrax Lite set sold separately (REQU327).

2.5

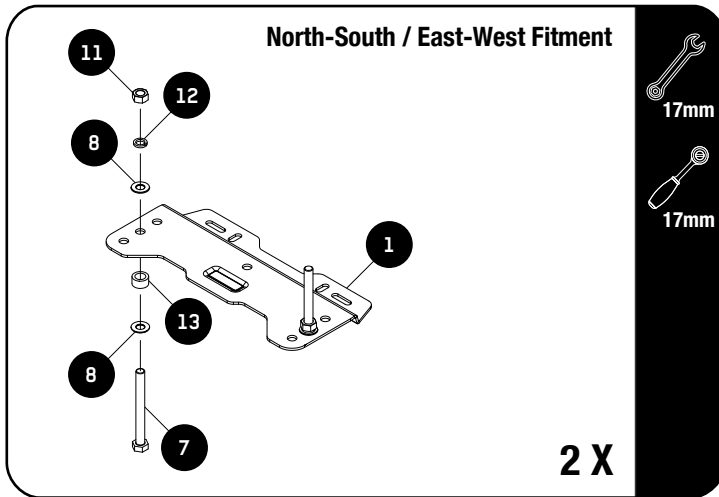

**4 X MAXTRAX LITE**

For 4 x MaxTrax Lite use the specified hardware.

Fully tighten the M10x100 Hex Bolts SS, M10x21x1.2 Flat Washers, 19x12.5x10 Tube Spacers, M10 Spring Washers & M10 Nuts SS (Items 7, 8, 13, 12 & 11) to the Base Bracket (Item 1) as shown.

You will need two of these assemblies.

MaxTrax Mini set sold separately (REQU327).

2.6

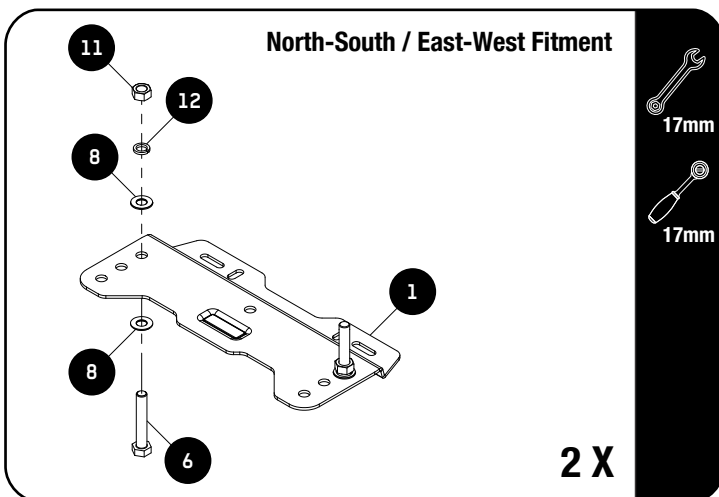

**2 X MAXTRAX MKII**

For 2 x MaxTrax MKII use the specified hardware.

Fully tighten the M10x60 Hex Bolts SS, M10x21x1.2 Flat Washers, M10 Spring Washers & M10 Nuts SS (Items 6, 8, 12 & 11) to the Base Bracket (Item 1) as shown.

You will need two of these assemblies.

MaxTrax MKII set sold separately (REQU119), we have a range of colour options available.

**FIT AND SECURE - SELECT RECOVERY BOARD HARDWARE**

2.7

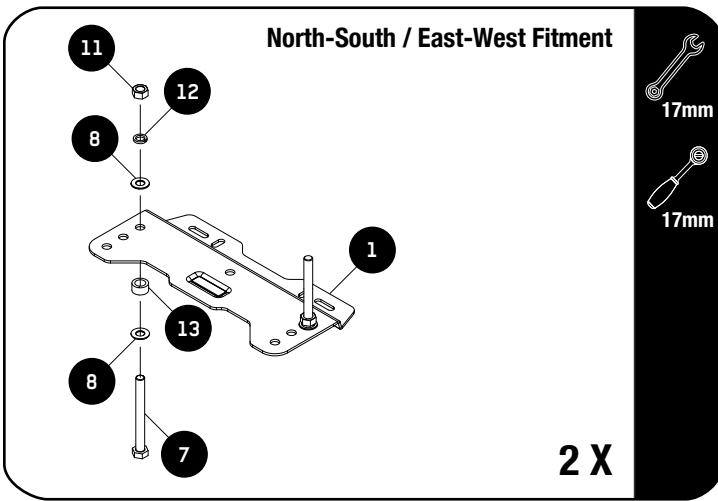

**4 X MAXTRAX MKII**

For 4 x MaxTrax MKII use the specified hardware.

Fully tighten the M10x100 Hex Bolts SS, M10x21x1.2 Flat Washers, 19x12.5x10 Tube Spacers, M10 Spring Washers & M10 Nuts SS (Items 7, 8, 13, 12 & 11) to the Base Bracket (Item 1) as shown.

You will need two of these assemblies.

MaxTrax MKII set sold separately (REQU119), we have a range of colour options available.

2.8

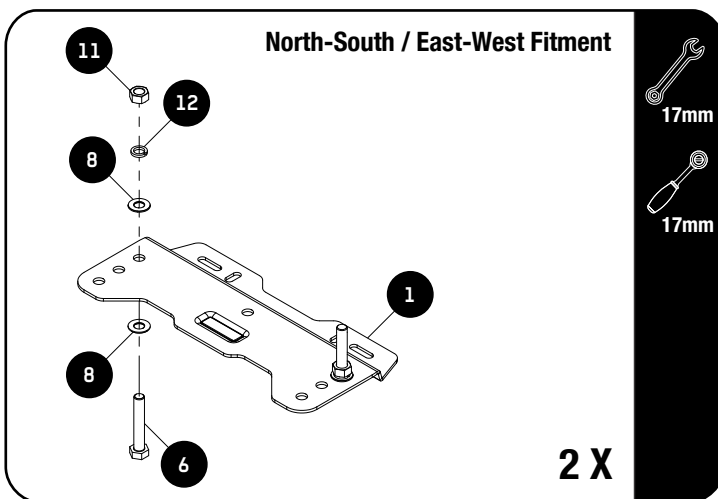

**2 X MAXTRAX XTREME**

For 2 x MaxTrax Xtreme use the specified hardware.

Fully tighten the M10x60 Hex Bolts SS, M10x21x1.2 Flat Washers, M10 Spring Washers & M10 Nuts SS (Items 6, 8, 12 & 11) to the Base Bracket (Item 1) as shown.

You will need two of these assemblies.

MaxTrax Xtreme set sold separately (REQU229), we have a range of colour options available.

2.9

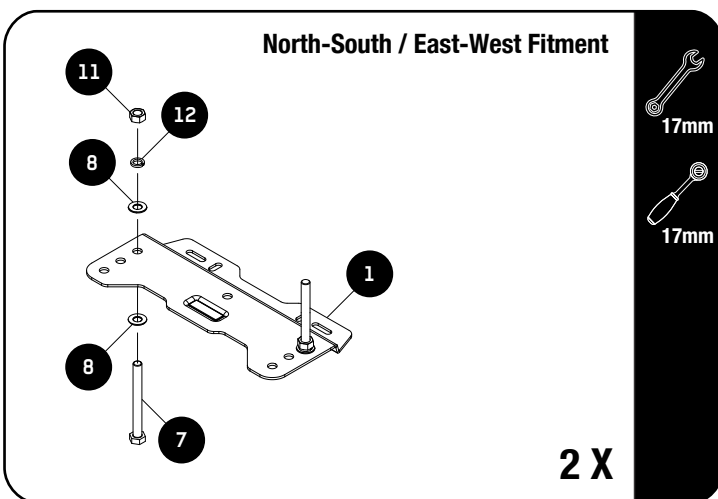

**4 X MAXTRAX XTREME**

For 4 x MaxTrax Xtreme use the specified hardware.

Fully tighten the M10x100 Hex Bolts SS, M10x21x1.2 Flat Washers, M10 Spring Washers & M10 Nuts SS (Items 7, 8, 12 & 11) to the Base Bracket (Item 1) as shown.

You will need two of these assemblies.

MaxTrax Xtreme set sold separately (REQU229), we have a range of colour options available.

**FIT AND SECURE - SELECT RECOVERY BOARD HARDWARE**

2.10

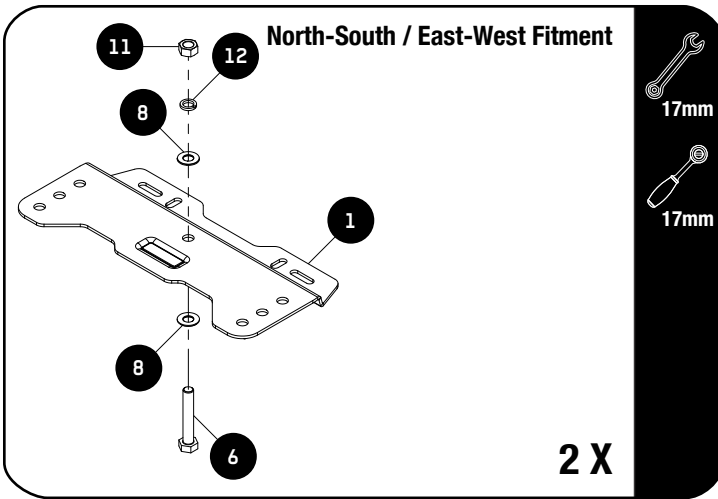

**2 X TRED PRO**



For 2 x Tred Pro use the specified hardware.

Fully tighten the M10x60 Hex Bolt SS, M10x21x1.2 Flat Washer, M10 Spring Washer & M10 Nut SS (Items 6, 8, 12 & 11) to the Base Bracket (Item 1) as shown.

You will need two of these assemblies.

Tred Pro set sold separately.

2 X

2.11

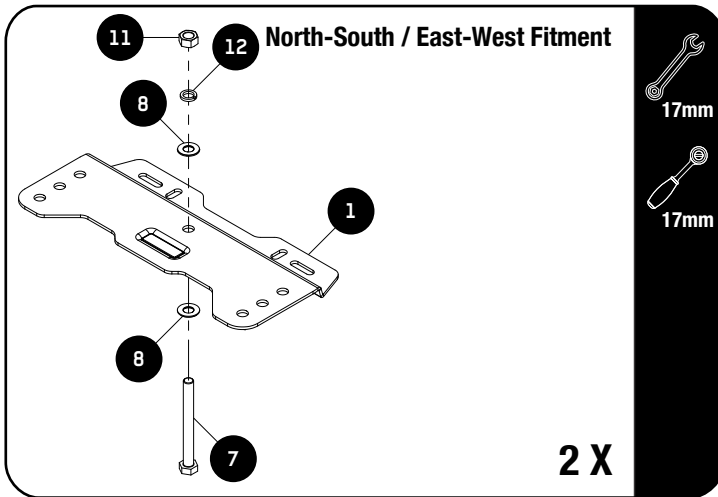

**4 X TRED PRO**



For 4 x Tred Pro use the specified hardware.

Fully tighten the M10x100 Hex Bolt SS, M10x21x1.2 Flat Washer, M10 Spring Washer & M10 Nut SS (Items 7, 8, 12 & 11) to the Base Bracket (Item 1) as shown.

You will need two of these assemblies.

Tred Pro set sold separately.

2 X

2.12

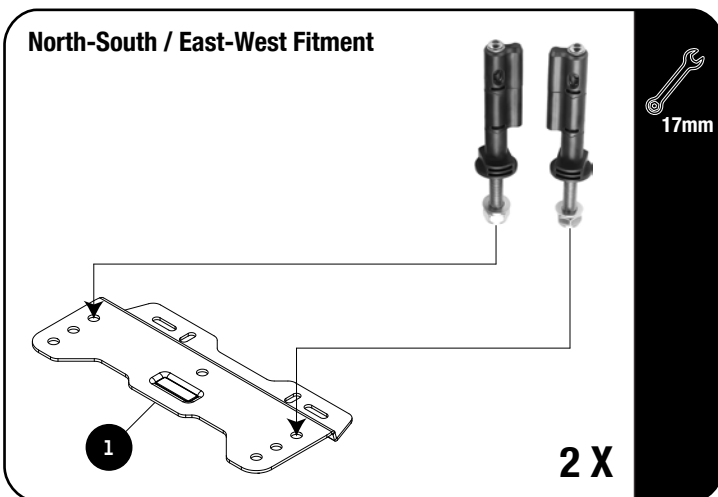

**MAXTRAX MOUNTING PINS**



MaxTrax Mounting Pins can be substituted for the standard hardware for MKII & Xtreme recovery boards.

MaxTrax Mounting Pin Set sold separately (REQU120), for 2 - 4 MKII recovery boards.

MaxTrax Mounting Pin Set Xtreme sold separately (REQU259), for 2 - 4 Xtreme recovery boards.

**NOTE:** When mounting (E-W) the short threaded version of the mounting Pins should be used or cut shorter.

2 X

3

**FIT AND SECURE - TO A ROOF RACK**

3.1

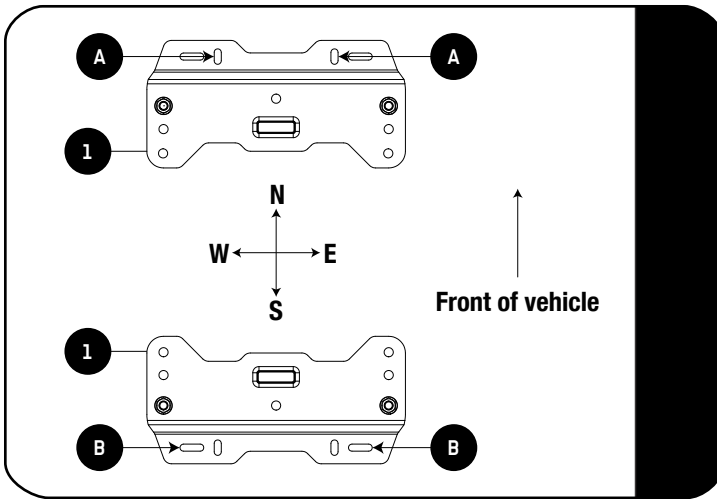

Before mounting the Base Brackets (Item 1) to your rack, choose the orientation that the recovery boards will be mounted, (N-S) or (E-W) as shown.

Use the vertical slots when mounting (N-S) as shown by (A) and the horizontal slots when mounting (E-W) as shown by (B).

3.2

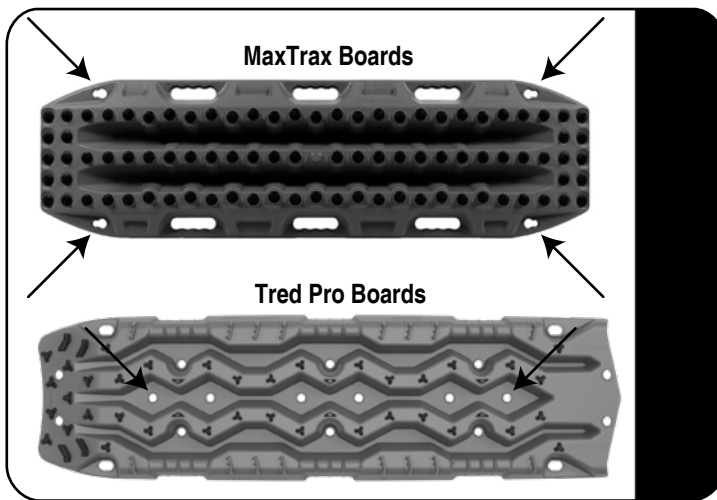

To locate the recovery board to the Base Brackets (Item 1) use the specified mounting holes as shown.

Use the recovery board as a guide to determine the position of your recovery boards on the roof rack.

**NOTE:** The number of slats used for each type of recovery board.

- Mini & Jaxbase Combo - 4 x slats (N-S)
- Lite - 5 x Slats (N-S)
- MKII - 6 x Slats (N-S)
- Xtreme - 6 x Slats (N-S)
- Tred Pro - 5 x Slats (N-S)

3.3

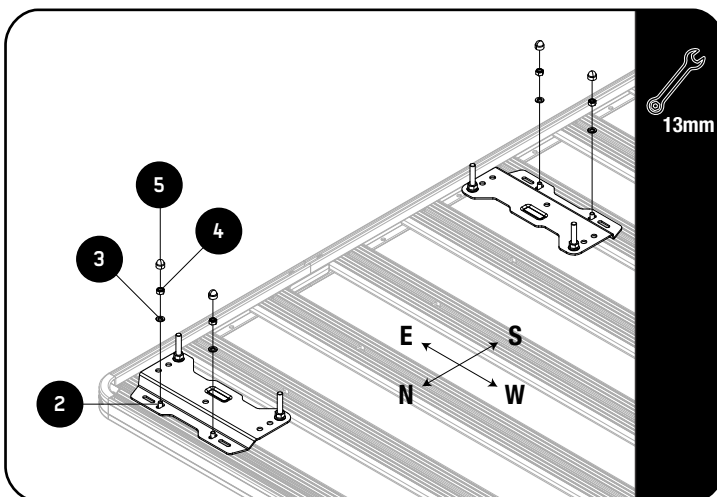

Assemble the Base Brackets (Item 1) to your roof rack by fully tightening the M8x16 Hex Bolts, M8x16x1.6 Flat Washers & M8 Nyloc Nuts (Items 2, 3 & 4).



**Tightening Torque:**

**M8 : 15-20Nm / 11.06 ft lb - 14.75 ft lb**

Place the M8 Nut Caps (Item 5) over the M8 Nyloc Nuts (Item 4) as shown.

3

**FIT AND SECURE - TO A ROOF RACK**

3.4

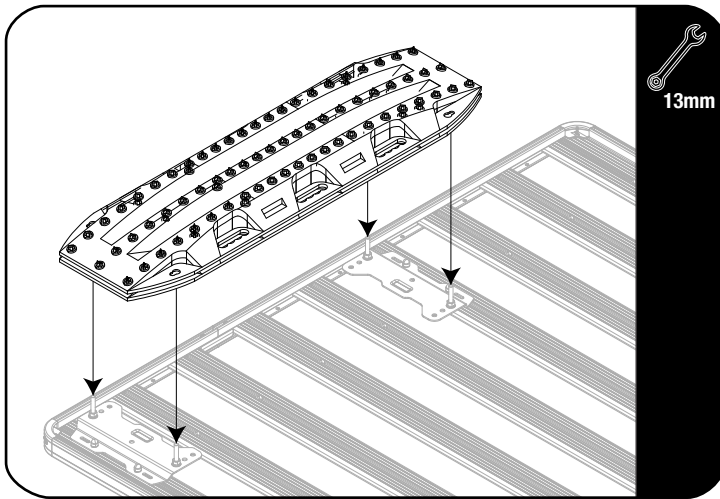

Place your recovery boards onto the recovery device brackets as shown.

3.5

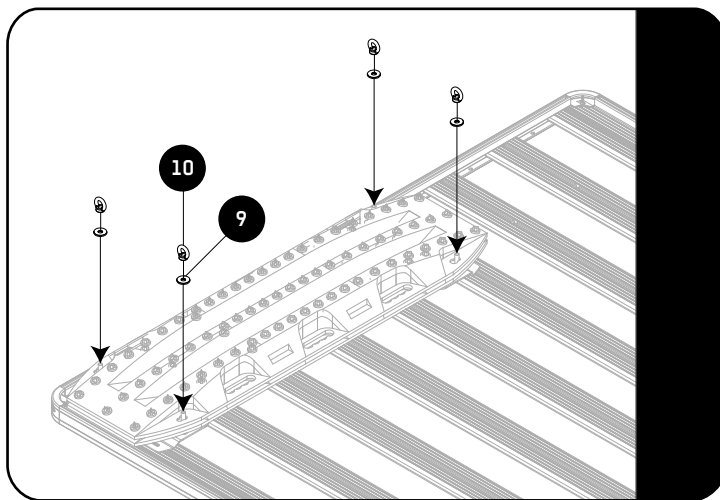

To secure your recovery boards hand tighten the M10x30x3 Flat Washers & M10 Eye Nuts (Items 9 & 10) as shown.

**TIP:** By cross strapping two Stratchits (STRA034) to the M10 Eye Nuts (Item 10) you are able to secure loose items like a bag to your roof rack without losing any storage capacity.

4

**FINISH**

Congratulations! You did it. Take a step back and admire your work!

5

**INSTALL OTHER VEHICLE AND RACK ACCESSORIES**

Now's the time to visit your favorite Front Runner Dealer in person or online.

Be sure to tag us. We love to see our gear in action! #FrontRunnerOutfitters

Share your adventures on:

